

Axial fans AP6



Installation in the wall or ceiling



A plastic rotor reinforced with fiberglass



Adapted for voltage speed control

Design

Axial fan for wall or ceiling mounting. Mounting plate made of powder coated steel sheet. Rotor made of plastic, reinforced with glass fiber.

Usage

Ventilation of large spaces, such as factories, warehouses, workshops, paint shops, assembly halls, shopping centers.

Electric motor

Asynchronous single phase 230V, 50Hz. Suitable for voltage speed control or frequency converter (3 phase products). Protection class IP 44, insulation class B.

Operating temperature

The fan is designed to transmit air with a temperature not exceeding 45°C.

Technical specifications

Model	Air flow [m³/h]	Impeller speed [rpm]	Power [W]	Current [A]	Voltage [V]	Frequency [Hz]	Sound pressure level [dB(A)]	Weight [kg]	Controller HRX	Controller HRB	Frequency converter for 3~ products
AP6-250/2000 M / AP6-250/2000 T	1500	1450	70/120	0,4/0,75	230/400	50	54	7,3	1,0	1,5	Yes
AP6-300/3000 M / AP6-300/3000 T	2390	1450	85/150	0,45/0,65	230/400	50	57	8,5	1,0	1,5	Yes
AP6-350/4000 M / AP6-350/4000 T	4080	1400	250/190	1,22/0,8	230/400	50	60	9,9	2,5	1,5	Yes
AP6-400/5500 M / AP6-400/5500 T	5200	1375	255/255	1,24/0,8	230/400	50	63	10,4	2,5	1,5	Yes
AP6-450/7000 M / AP6-450/7000 T	6100	1250	360/290	1,6/0,82	230/400	50	61	11,4	2,5	3,0	Yes
AP6-500/8000 M / AP6-500/8000 T	7200	1250/1375	440/370	2,0/0,84	230/400	50	66	13,6	2,5	3,0	Yes

Sound pressure level measured outdoor at 3 m.

Technical drawing

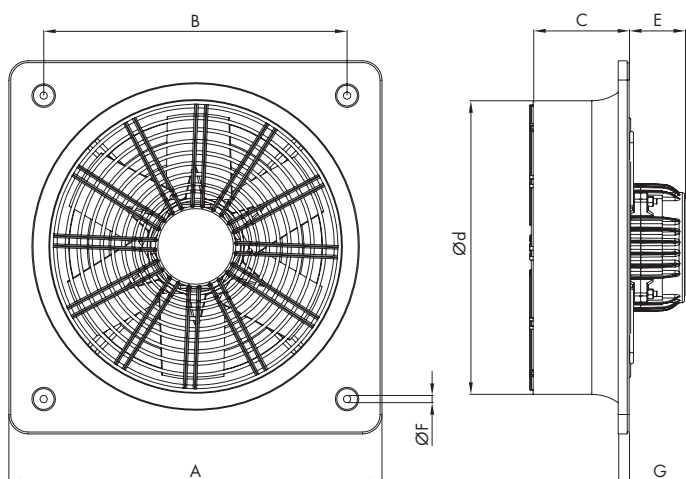

Dimensions [mm]

Model	A	B	C	Ød	E	ØF	G
AP6-250/2000	333	275	80	261	80	8,25	10
AP6-300/3000	412	336	80	307	80	8,25	10
AP6-350/4000	465	390	90	365	80	8,25	10
AP6-400/5500	500	420	100	403	80	8,25	10
AP6-450/7000	560	480	105	462	80	8,25	10
AP6-500/8000	630	561	110	513	80	8,25	10

Accessories



HRX
Electronic speed controller
page 174



HRB
Transformer speed controller
page 176



WSH
Service switch
page 177

Characteristics

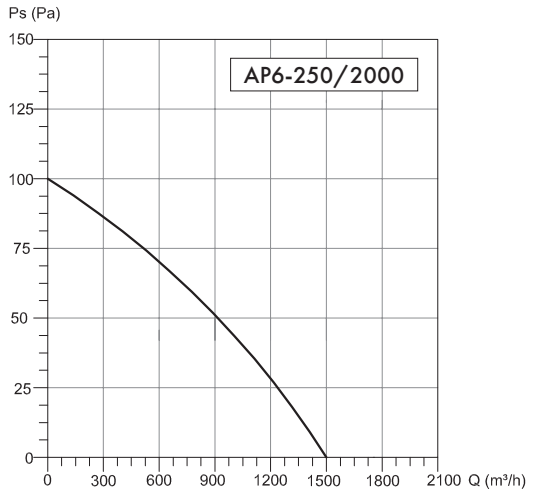

Frequency	Total	63	125	250	500	1000	2000	4000	8000	Hz
L_{WA} Inlet	75	43	57	64	69	70	69	64	56	dB(A)

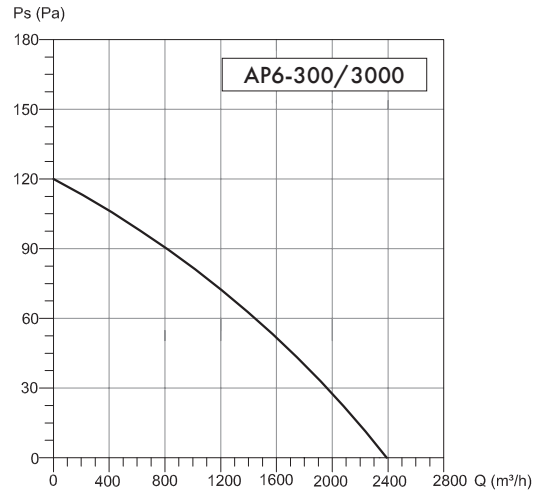

Frequency	Total	63	125	250	500	1000	2000	4000	8000	Hz
L_{WA} Inlet	78	51	63	69	71	73	70	65	60	dB(A)

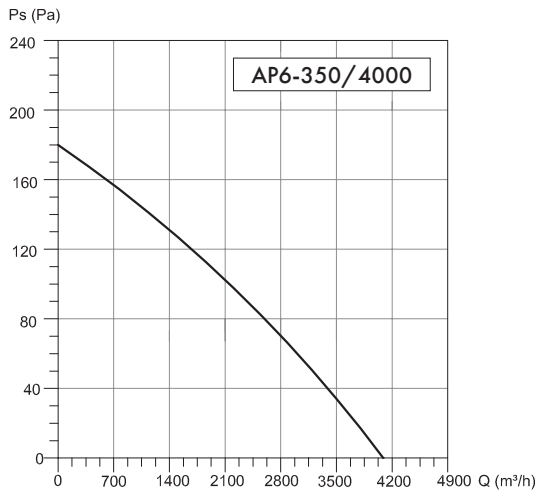

Frequency	Total	63	125	250	500	1000	2000	4000	8000	Hz
L_{WA} Inlet	81	47	66	65	72	78	72	70	61	dB(A)

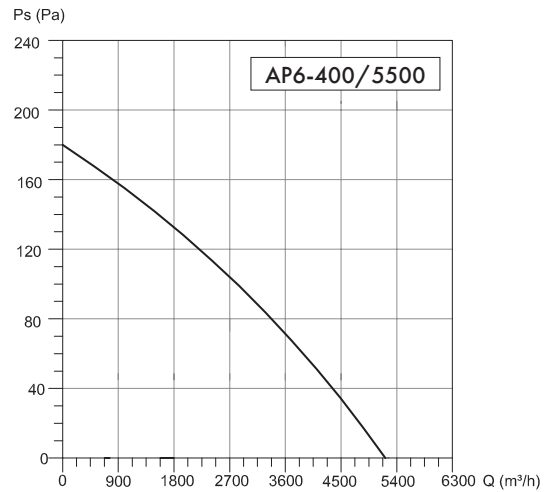

Frequency	Total	63	125	250	500	1000	2000	4000	8000	Hz
L_{WA} Inlet	84	56	69	70	77	80	77	72	63	dB(A)

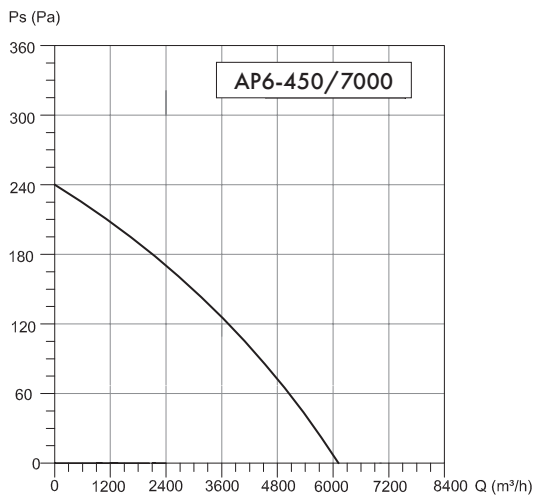

Frequency	Total	63	125	250	500	1000	2000	4000	8000	Hz
L_{WA} Inlet	82	49	68	65	71	78	77	72	64	dB(A)

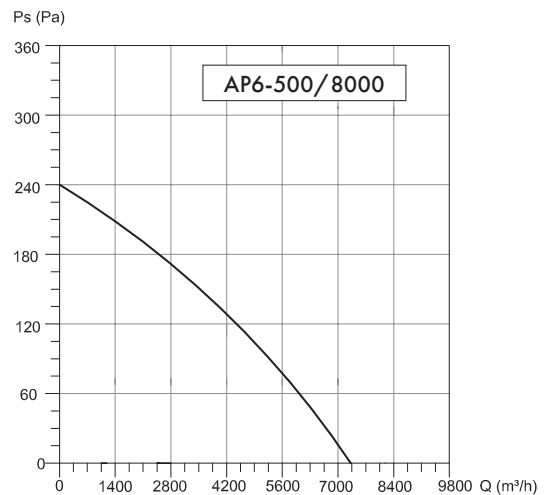

Frequency	Total	63	125	250	500	1000	2000	4000	8000	Hz
L_{WA} Inlet	87	54	73	74	78	82	81	77	70	dB(A)